

QUIÑENCO S.A. CORPORATE STRUCTURE

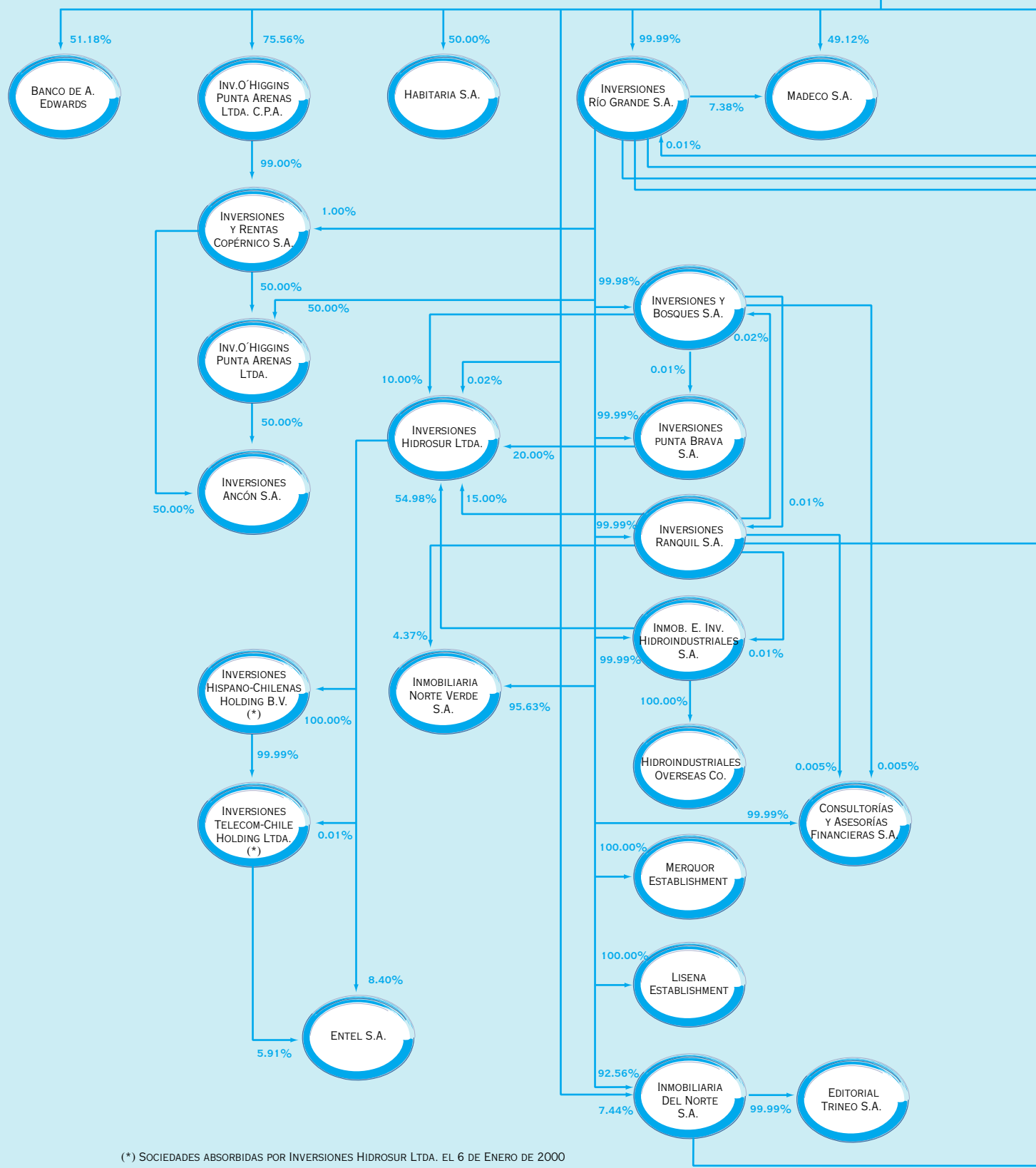

SUBSIDIARIES AND AFFILIATES

QUIÑENCO S.A. SUBSIDIARIES AND AFFILIATES



(*) SOCIEDADES ABSORVIDAS POR INVERSIONES HIDROSUR LTDA. EL 6 DE ENERO DE 2000

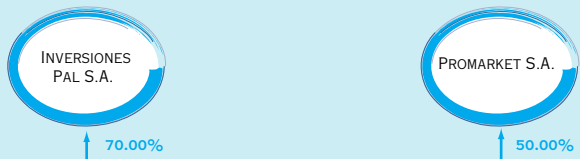
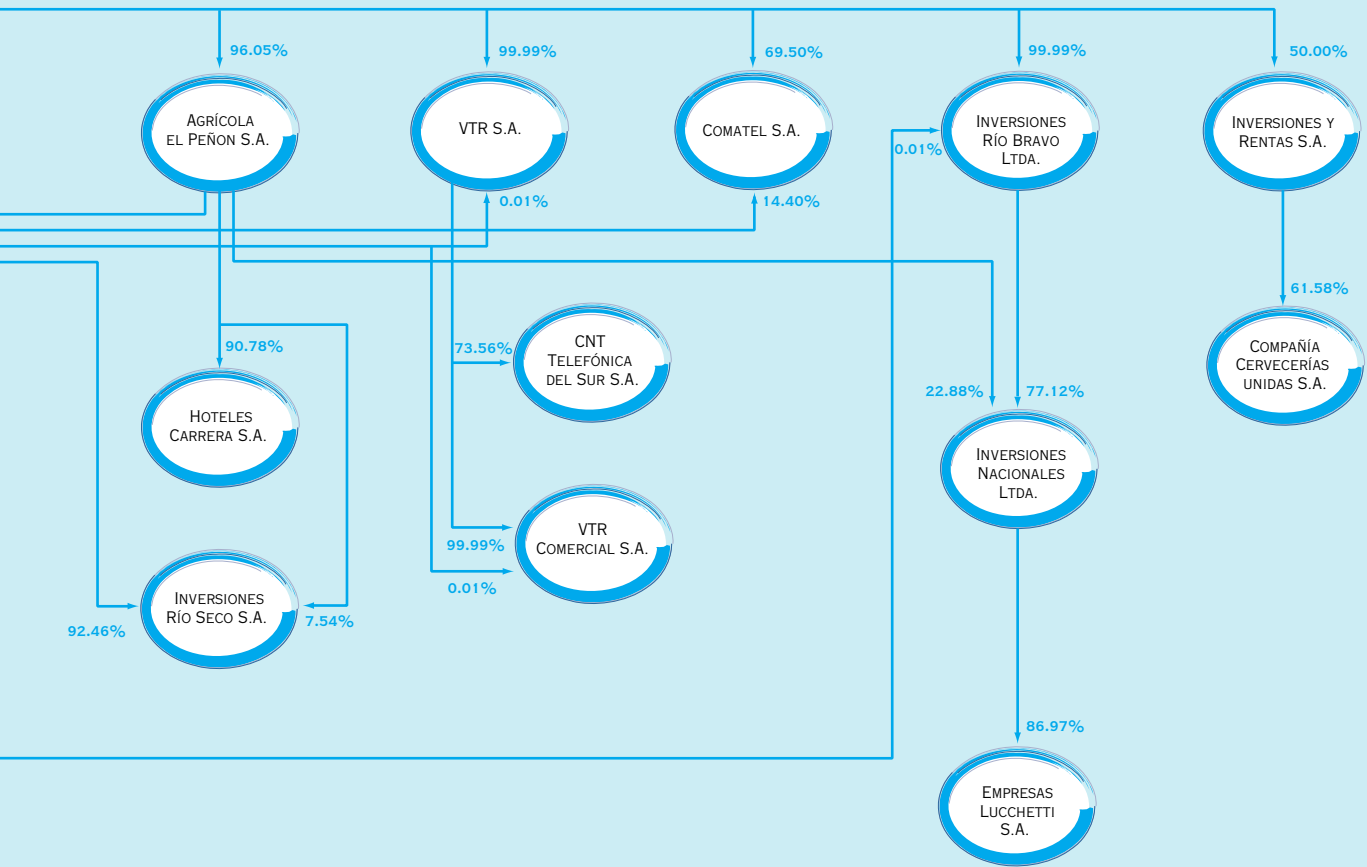

BANCO DE A. EDWARDS AND SUBSIDIARIES

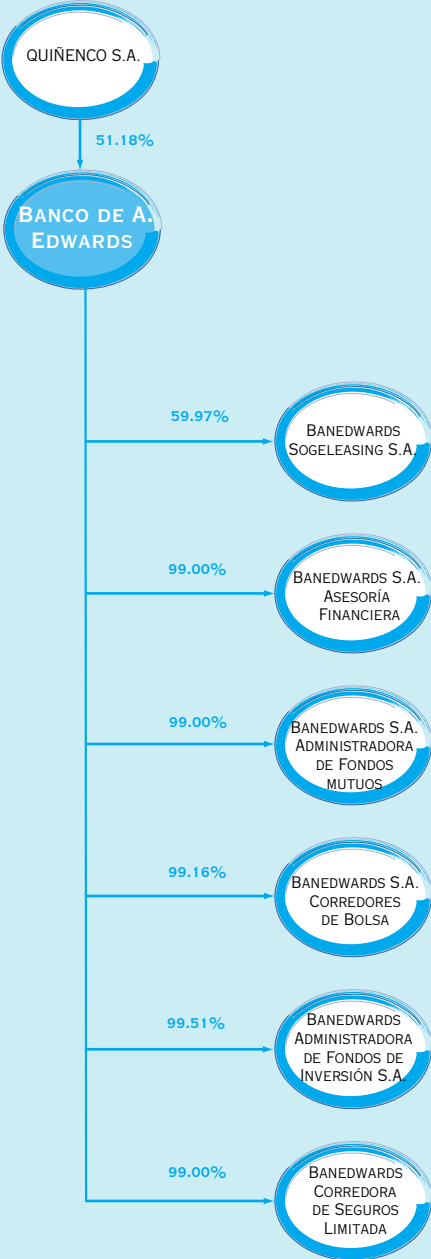

COMPAÑÍA CERVECERÍAS UNIDAS S.A. SUBSIDIARIES AND AFFILIATES

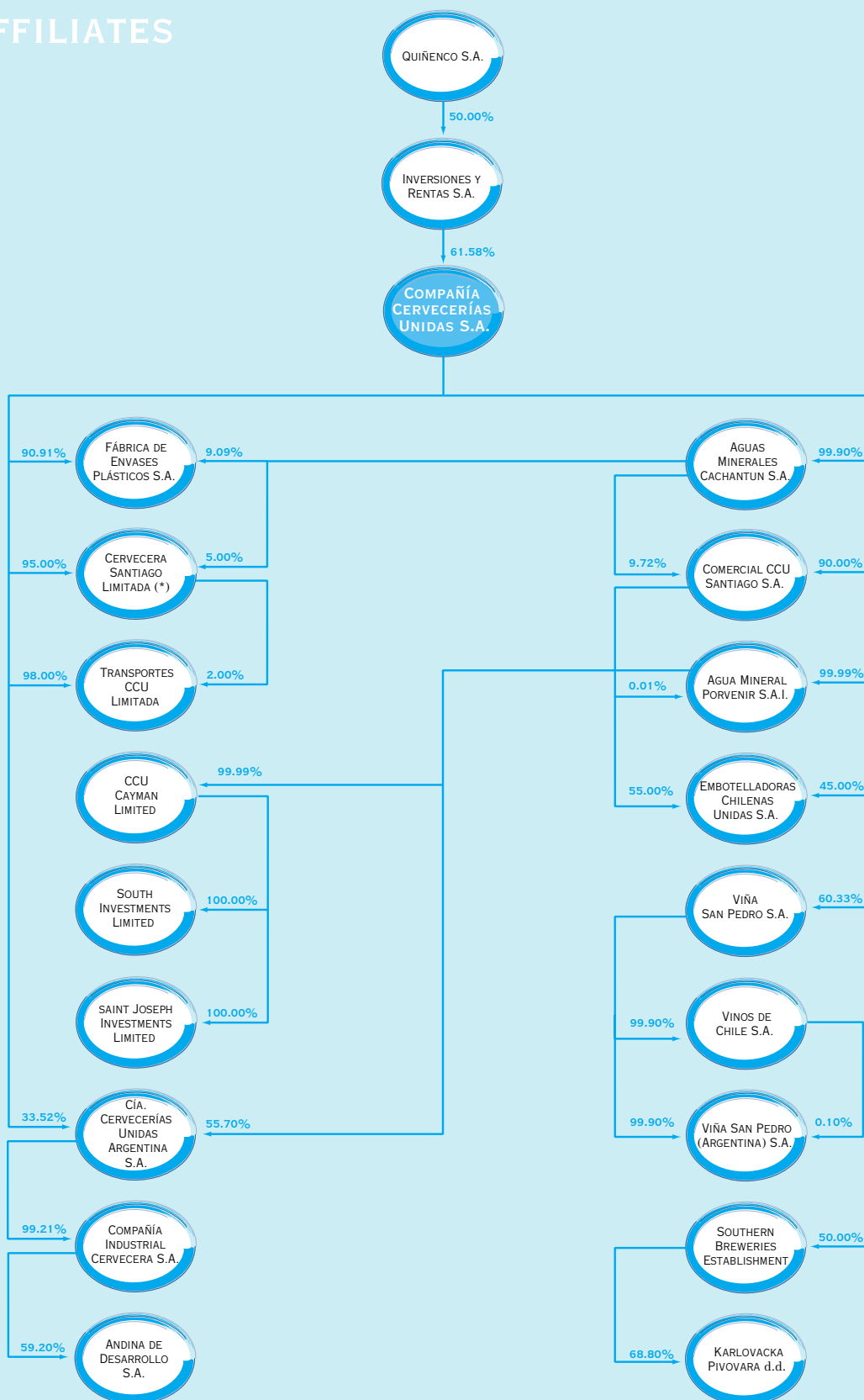

(*) AS OF JANUARY 1, 2000 THE NAME HAS BEEN CHANGED TO "CERVECERA CCU CHILE LIMITADA"

MADECO S.A. SUBSIDIARIES AND AFFILIATES

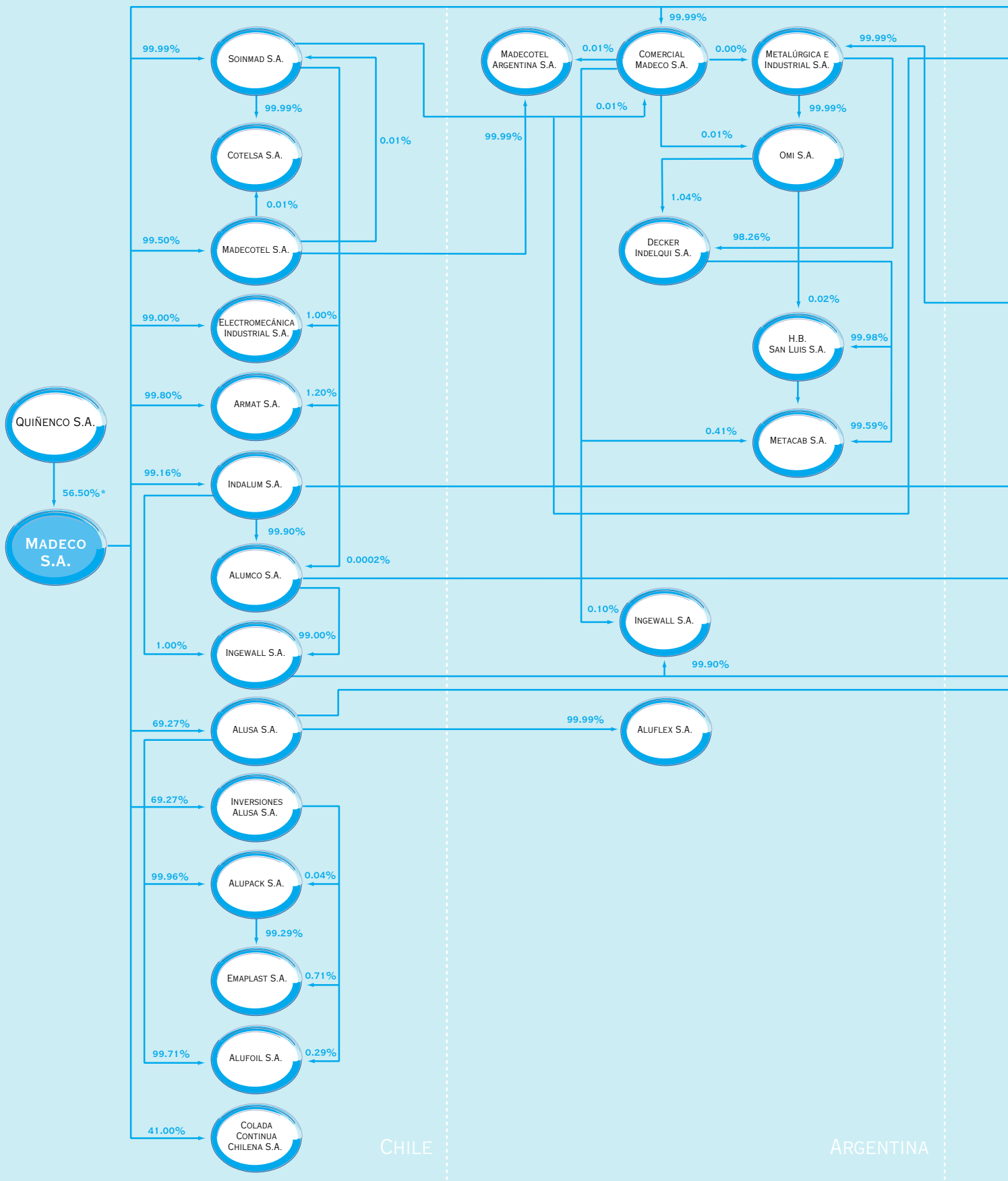

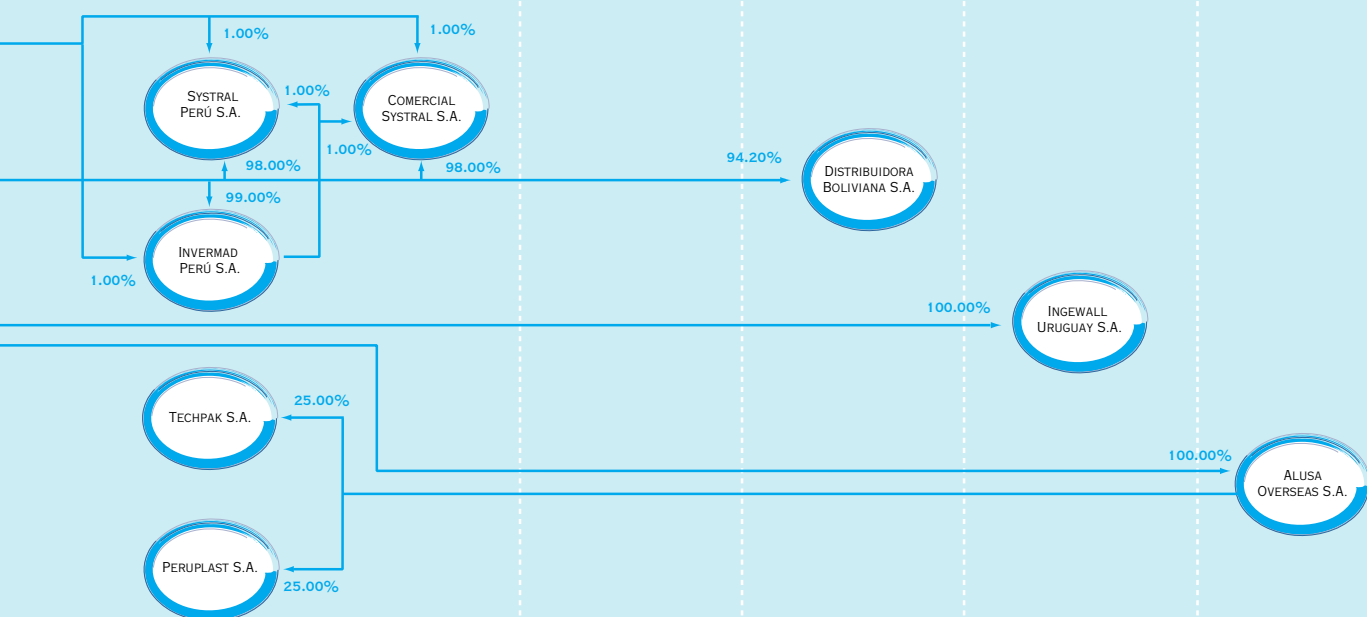
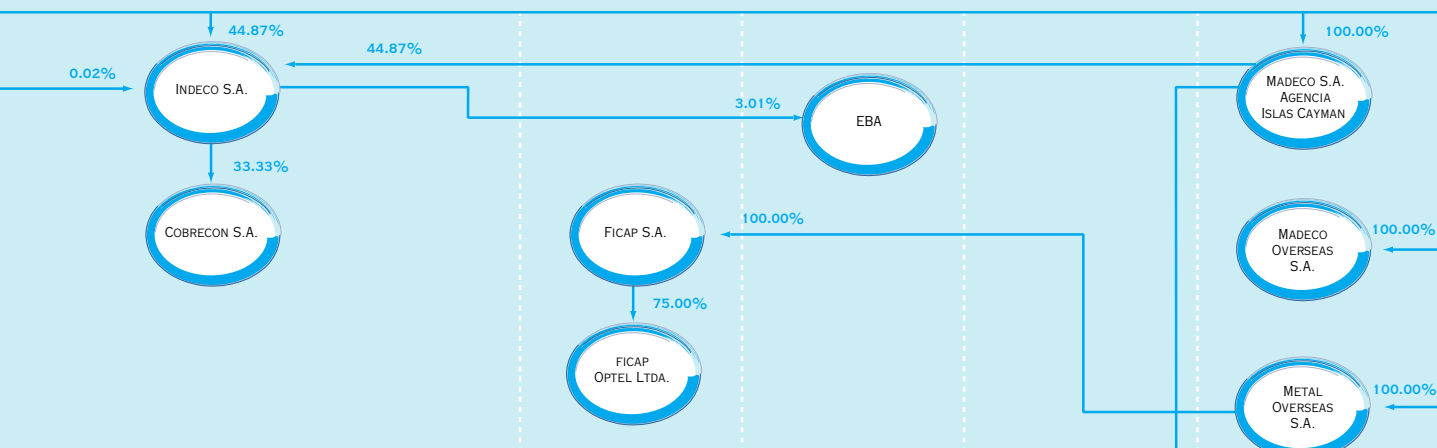

PERÚ

BRASIL

BOLIVIA

URUGUAY

ISLAS
CAYMAN

COMPAÑÍA NACIONAL DE TELÉFONOS, TELEFÓNICA DEL SUR S.A. AND SUBSIDIARIES

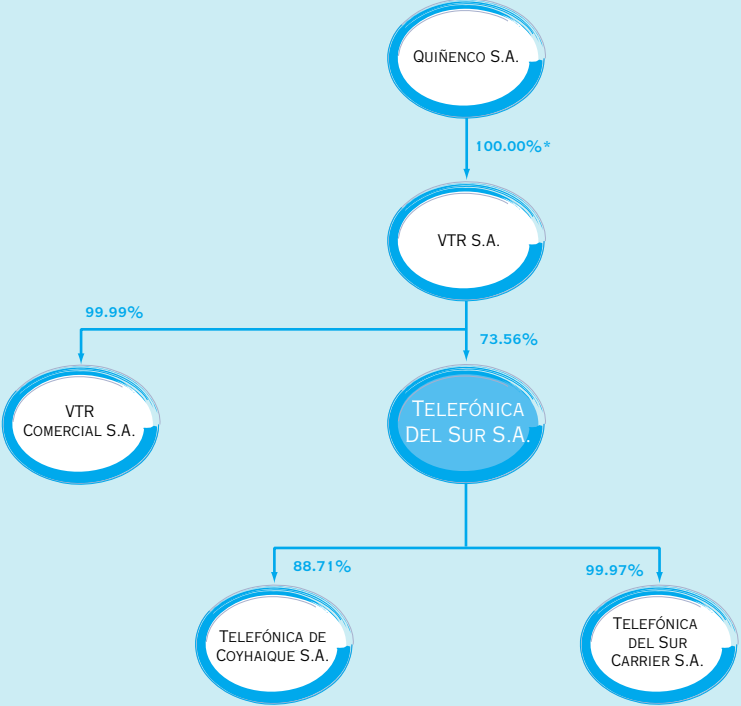

EMPRESAS LUCCHETTI S.A. SUBSIDIARIES AND AFFILIATES

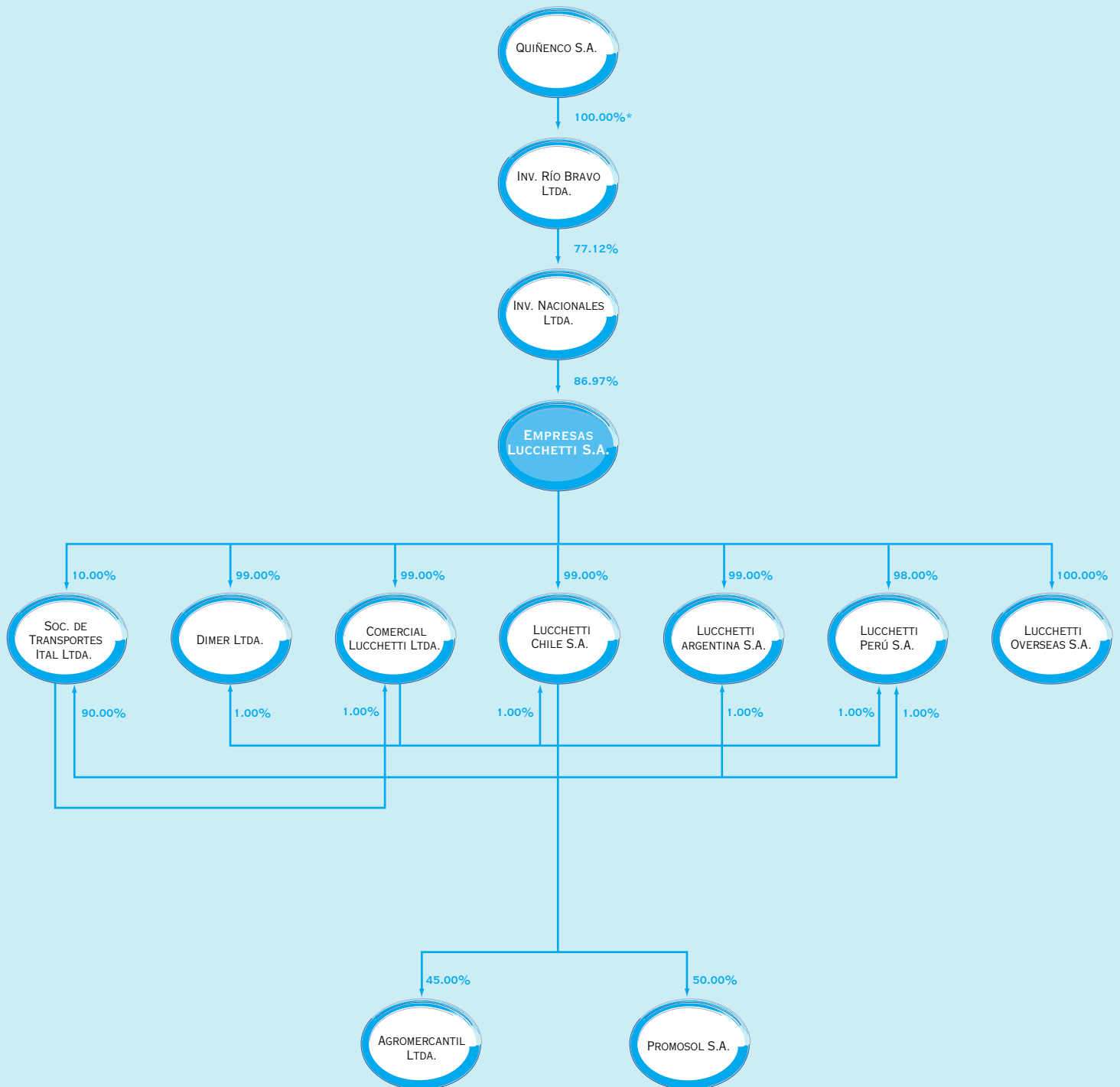

AGRÍCOLA EL PEÑÓN S.A. AND SUBSIDIARY HOTELES CARRERA S.A.



HABITARIA S.A. SUBSIDIARIES AND AFFILIATES

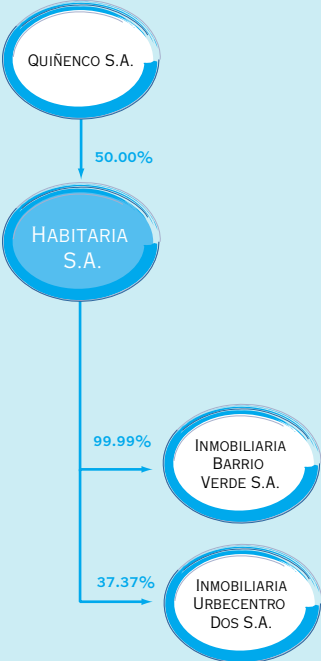

CORPORATE INFORMATION

QUIÑENCO S.A.
ENRIQUE FOSTER SUR 20, PISO 14
LAS CONDES, SANTIAGO, CHILE
TELEPHONE: (56-2) 750 7100
FAX: (56-2) 750 7101
CHILEAN TAX ID (R.U.T.): 91.705.000-7

ANNUAL SHAREHOLDERS' MEETING

THE ANNUAL SHAREHOLDERS' MEETING
WILL BE HELD ON FRIDAY, APRIL 28, 2000
AT 12:00 P.M. IN THE JOSÉ MIGUEL SALON
OF THE HOTEL CARRERA (TEATINOS 180,
SANTIAGO, CHILE).

INVESTOR RELATIONS

CALL (56-2) 750 7100
OR CONTACT OUR REPRESENTATIVE IN THE
UNITED STATES:
CITIGATE DEWE ROGERSON
1440 BROADWAY
NEW YORK, NY 10018
TELEPHONE: (212) 688 6840

STOCK

TICKER SYMBOL: LQ (NYSE)
QUIÑENCO (CHILEAN STOCK EXCHANGES)
SHAREHOLDERS AS OF DECEMBER 31,
1999: 2,816
SHARES OUTSTANDING AS OF DECEMBER
31, 1999: 1,079,740,079

STOCK EXCHANGES:
NYSE IN NEW YORK
BOLSA DE COMERCIO DE SANTIAGO
BOLSA DE COMERCIO DE VALPARAÍSO
BOLSA DE VALORES DE CHILE

DIVIDENDS:
THE DIVIDEND PROPOSED BY THE BOARD
OF DIRECTORS AT THE ANNUAL
SHAREHOLDERS' MEETING REGARDING
1999 NET INCOME WILL BE PAYABLE AS OF
MAY 10, 2000 TO SHAREHOLDERS OF
RECORD AS OF MAY 6, 2000.

SHAREHOLDERS' DEPARTMENT:
ENRIQUE FOSTER SUR 20, PISO 14
LAS CONDES, SANTIAGO, CHILE
TELEPHONE: (56-2) 750 7100

AUDITORS

PRICE WATERHOUSE
HUÉRFANOS 863, PISO 4
SANTIAGO, CHILE
TELEPHONE: (56-2) 661 0000